

**TRITON**<sup>®</sup>

Catalog 2023

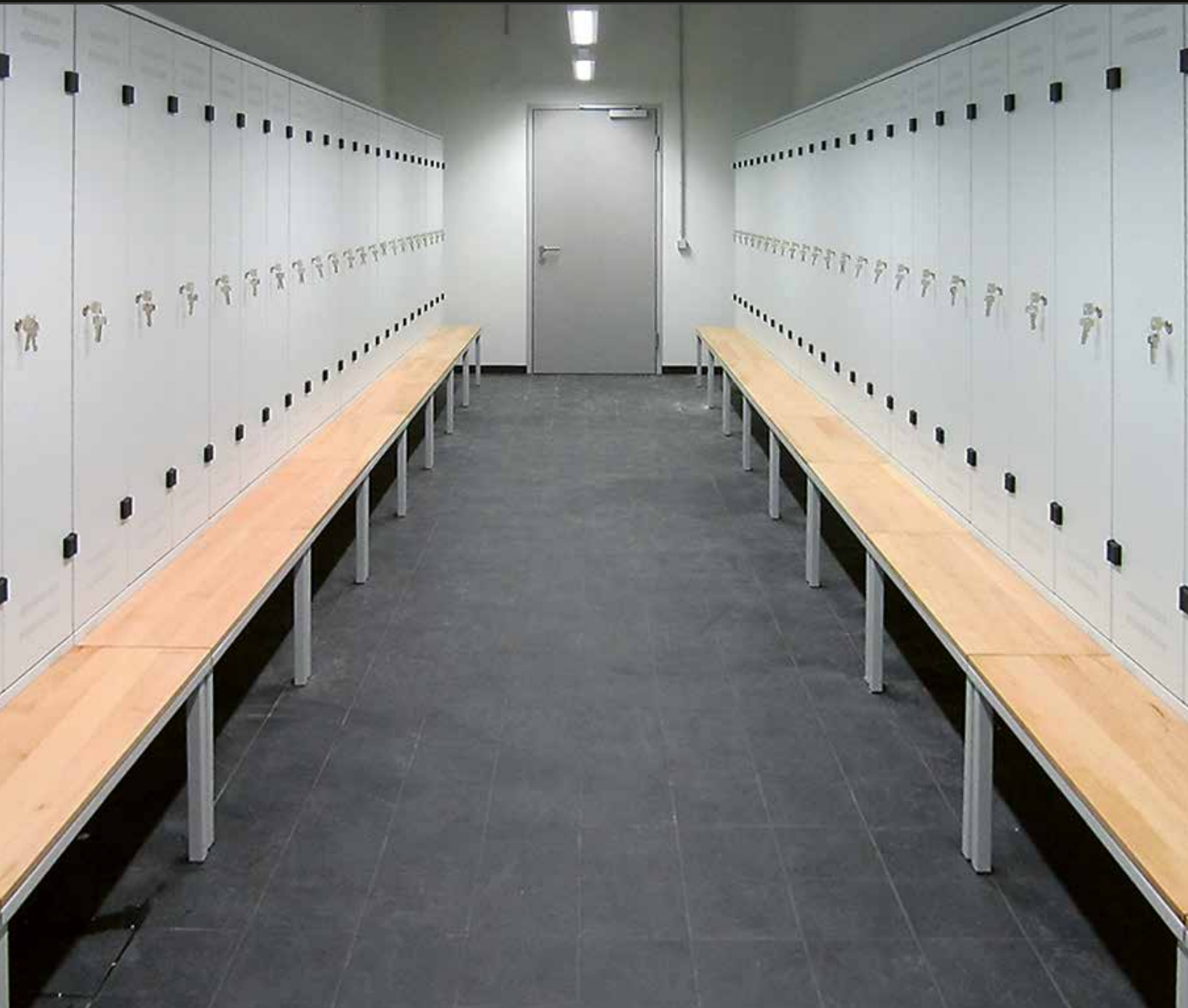

CLOAKROOM EQUIPMENT



[www.shop.satniskrinky.cz](http://www.shop.satniskrinky.cz)  
[www.clotheslockers.eu](http://www.clotheslockers.eu)

# Content

About Company .....	4
Modular .....	8
Combined clothes lockers.....	12
Laminated clothes lockers .....	20
Steel clothes lockers .....	24
Golf lockers .....	32
Saddle locker .....	36
Ball locker .....	38
Hockey box and multipurpose boxes .....	40
Ski and snowboard lockers .....	46
Fire lockers and lockers for rescue services .....	50
Key lockers .....	58
Cloakroom seats .....	60
Whole laminated wardrobe bench .....	62
Design self-watering flowerpot .....	63
Shelf racks .....	64
Workbenches .....	66
Container .....	68
Additional steel production and cooperation .....	69
Multifunctional storage wall .....	72
Mail box .....	74
Stand for Disinfectant Dispenser.....	75
Hygienestand .....	76
Accessories .....	78
Locks.....	80
Project realization .....	87
Offer warehouse decors .....	88
Extended offer of decors .....	90
References .....	92
Marketing – Exhibitions .....	100
Presentation .....	102
Packaging, transportation .....	103
Notes .....	104
Certificates .....	105





## About us

Tritón Pardubice, spol. s r. o. with almost 30 years of tradition is one of the world's leading manufacturers of 19" data, telecommunication and power cabinets including accessories.

The production and development centre is located in Stary Mateřov, 5 km from city Pardubice. Here is step by step built a modern production plant with a total production area of 17,000 m<sup>2</sup> and more than 190 employees and specialists.

In January 2022, the fifth production hall including a new logistics facility was finished.

Last but not least, the company develops and manufactures products used to equip changing rooms, workshops and offices. For example, cabinets, boxes, benches and hanging walls, hockey boxes, workshop furniture, special cabinets for firefighters or for sports equipment (balls, skis, snowboards, bridles, golf equipment etc.). Currently, the Anti-Covid program has been developed and put into production, which includes disinfectant and hygiene stands.



7. 12. In 2021, a new hall with a usable area of almost 3,000 m<sup>2</sup> was approved.



Automated bending center





Automated bending center



Automated bending center



Automated punch machine



Center for glass gluing and cabinet door seal applications





Cross-cut saw KP 500 Automat



Nesting machining center



Dowel insertion machine



Edgebander tempora F800



Automatic milling center with feeder

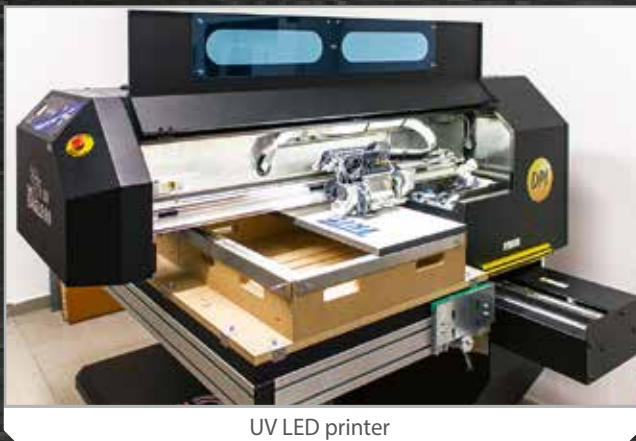

UV LED printer



Stacking machine for the production of pallets





# Modular

Triton Modular clothes lockers introduce a brand new and variable concept. The body is made of steel and can be adjusted to the customers' needs; whether they need a 2-door locker, 4-box, 6-box, 8-box, or other combinations.

Doors can be made of steel or laminated chipboard and can be oriented as left, right, or left/right. Quality Hettich hinges are used to attach them to the frame.

Doors are ready for cylindrical locks or turning locks BURG as standard. Shelves have integrated holders for clothes rods.

Sizes are 1970 x 600 x 500 mm, or 1970 x 800 x 500 mm (h x w x d).

All lockers are made of high quality steel and are delivered assembled.



Furniture hinges Hettich



Shelves with chromed clothes rod detail



Levelling feet



Modular lockers Triton can be customized to the most demanded options - all this with the use of just one frame. The body and dividing wall are perforated for different door, shelf and lock positions.

This versatility not only makes the delivery faster but also gives the customers the possibility to change the locker later, e.g. in case the customer needs to expand the locker room.

Steel parts are powder coated. Laminated chipboard doors are protected by 2 mm ABS edging.

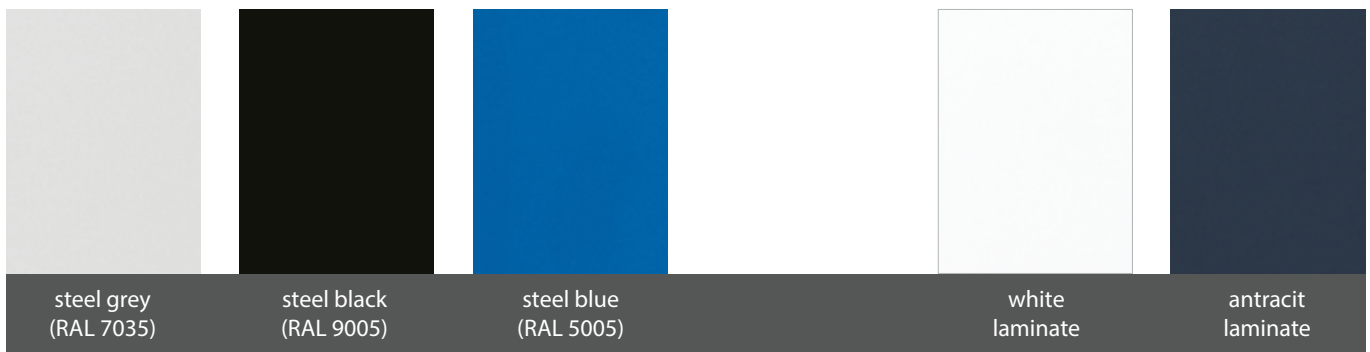

an extended range of decors can be found on page 90.



<b>2-door</b>		
Height x width x depth (mm)	1970 x 600 x 500	1970 x 800 x 500
Number of sections	2	2
Equipment	2 x shelf, 2 x rod	2 x shelf, 2 x rod
Weight net / gross (kg)	60 / 64	70 / 75
Order code	IVD-20-X65-XXX-X1	IVD-20-X85-XXX-X1



<b>4-box</b>		
Height x width x depth (mm)	1970 x 600 x 500	1970 x 800 x 500
Number of sections	4	4
Equipment	4 x rod	4 x rod
Weight net / gross (kg)	59 / 63	69 / 74
Order code	IVC-20-X65-XXX-X1	IVC-20-X85-XXX-X1

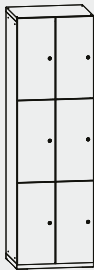

<b>6-box</b>		
Height x width x depth (mm)	1970 x 600 x 500	1970 x 800 x 500
Number of sections	6	6
Weight net / gross (kg)	60 / 65	71 / 76
Order code	IVE-20-X65-XXX-X1	IVE-20-X85-XXX-X1

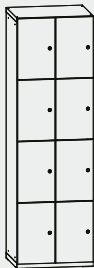

<b>8-box</b>		
Height x width x depth (mm)	1970 x 600 x 500	1970 x 800 x 500
Number of sections	8	8
Weight net / gross (kg)	63 / 68	74 / 79
Order code	IVF-20-X65-XXX-X1	IVF-20-X85-XXX-X1



Neubau Klinikum Fulda



AS Fitness Nový Jičín





I'M FIT Liberec



# Combined clothes lockers

Steel and laminated chipboard combination

Combined clothes lockers have bodies made of quality steel with powder coated finish and laminate chipboard with various decors. Lockers have pre-made holes if any shelves should be added.

Perforation in the steel frame ensures effective ventilation. Lockers can be screwed together to create one compact unit.

Lockers made of steel and laminated chipboard offer reliable and high quality equipment for locker rooms in companies, schools, sport facilities, hospitals, etc.

The basic color of steel corpus consists of a shade RAL 7035 and RAL 9005.



an extended range of decors can be found on page 90



Solid frame construction



Air system



Chrome bar



Unique hinges  
(180° door opening)



Practical shelves



Levelling feet





<b>1-door</b>			
Height x width x depth (mm)	1525 x 420 x 500	1750 x 420 x 500	1970 x 420 x 500
Number of sections	1	1	1
Equipment	1 x shelf, 1 x rod	1 x shelf, 1 x rod	2 x shelf, 1 x rod
Weight net / gross (kg)	31 / 38	35 / 42	39 / 45
Order code	ISS-15-B45-XXX-X2	ISS-18-B45-XXX-X2	ISS-20-B45-XXX-X2

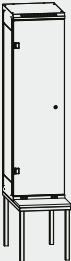

<b>1-door with a seat</b>		
Height x width x depth (mm)	1970 x 420 x 780	2195 x 420 x 780
Number of sections	1	1
Equipment	1 x shelf, 1 x rod	1 x shelf, 1 x rod
Weight net / gross (kg)	39 / 47	43 / 51
Order code	ISS-20-B48-XXX-A2	ISS-22-B48-XXX-A2



<b>2-door</b>			
Height x width x depth (mm)	1525 x 600 x 500	1750 x 600 x 500	1970 x 600 x 500
Number of sections	2	2	2
Equipment	2 x shelf, 2 x rod	2 x shelf, 2 x rod	4 x shelf, 2 x rod
Weight net / gross (kg)	48 / 54	54 / 60	62 / 69
Order code	ISD-15-B65-XXX-X2	ISD-18-B65-XXX-X2	ISD-20-B65-XXX-X2

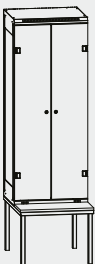

<b>2-door with a seat</b>		
Height x width x depth (mm)	1970 x 600 x 780	2195 x 600 x 780
Number of sections	2	2
Equipment	2 x shelf, 2 x rod	2 x shelf, 2 x rod
Weight net / gross (kg)	57 / 65	63 / 71
Order code	ISD-20-B68-XXX-A2	ISD-22-B68-XXX-A2

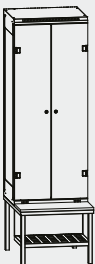

<b>2-door with a seat with integrated grate</b>		
Height x width x depth (mm)	1970 x 600 x 780	2195 x 600 x 780
Number of sections	2	2
Equipment	2 x shelf, 2 x rod	2 x shelf, 2 x rod
Weight net / gross (kg)	61 / 69	67 / 75
Order code	ISD-20-B68-XXX-R2	ISD-22-B68-XXX-R2

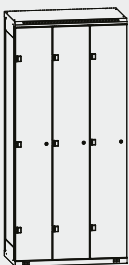

<b>3-door</b>		
Height x width x depth (mm)	1750 x 900 x 500	1970 x 900 x 500
Number of sections	3	3
Equipment	3 x shelf, 3 x rod	6 x shelf, 3 x rod
Weight net / gross (kg)	74 / 80	86 / 91
Order code	IST-18-B95-XXX-X2	IST-20-B95-XXX-X2



2-door locker, grey RAL 7035/cherry-tree locarno laminate



3-door locker, grey RAL 7035/maple mandal laminate



2-door locker, grey RAL 7035/maple mandal



2-door locker with a bench, grey RAL 7035/pine laminate



2-door locker with a bench, grey RAL 7035/cherry-tree locarno laminate

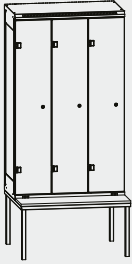

<b>3-door with a seat</b>		
Height x width x depth (mm)	1970 x 900 x 780	2195 x 900 x 780
Number of sections	3	3
Equipment	3 x shelf, 3 x rod	3 x shelf, 3 x rod
Weight net / gross (kg)	77 / 85	85 / 90
Order code	IST-20-B98-XXX-A2	IST-22-B98-XXX-A2

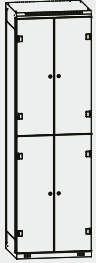

<b>4-box</b>			
Height x width x depth (mm)	1525 x 600 x 500	1750 x 600 x 500	1970 x 600 x 500
Number of sections	4	4	4
Equipment	4 x rod	4 x rod	4 x rod
Weight net / gross (kg)	49 / 57	54 / 60	59 / 66
Order code	ISC-15-B65-XXX-X2	ISC-18-B65-XXX-X2	ISC-20-B65-XXX-X2

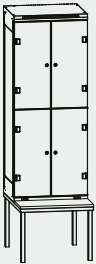

<b>4-box with a seat</b>		
Height x width x depth (mm)	1970 x 600 x 780	2195 x 600 x 780
Number of sections	4	4
Equipment	4 x rod	4 x rod
Weight net / gross (kg)	58 / 66	67 / 75
Order code	ISC-20-B68-XXX-A2	ISC-22-B68-XXX-A2

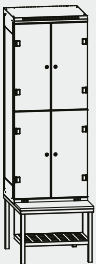

<b>4-box with a seat with integrated grate</b>		
Height x width x depth (mm)	1970 x 600 x 780	2195 x 600 x 780
Number of sections	4	4
Equipment	4 x rod	4 x rod
Weight net / gross (kg)	62 / 70	71 / 79
Order code	ISC-20-B68-XXX-R2	ISC-22-B68-XXX-R2

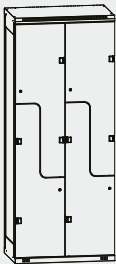

<b>„Z“-type</b>	
Height x width x depth (mm)	1970 x 800 x 500
Number of sections	4
Equipment	4 x rod
Weight net / gross (kg)	69 / 77
Order code	ISZ-20-B85-XXX-X2

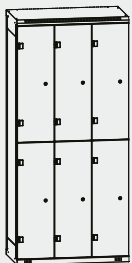

<b>6-box</b>	
Height x width x depth (mm)	1970 x 900 x 500
Number of sections	6
Equipment	6 x rod
Weight net / gross (kg)	78 / 88
Order code	ISE-20-B95-XXX-X2

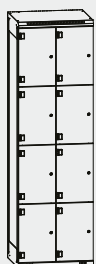

<b>8-box</b>	
Height x width x depth (mm)	1970 x 600 x 500
Number of sections	8
Equipment	-
Weight net / gross (kg)	59 / 66
Order code	ISF-20-B65-XXX-X2



4-box locker,  
grey RAL 7035/maple mandal  
laminat



4-box locker,  
grey RAL 7035/oak bardolino laminate



4-box locker with a bench,  
black RAL 9005/oak corbridge laminate



4-box „Z“ locker,  
grey RAL 7035/maple mandal laminate



6-box locker,  
black RAL 9005/oak bardolino laminate



8-box locker,  
black RAL 9005/maple mandal laminate





Amusement park Krokodýlek, Olomouc



Nordic Lockers



Golf Club Pyšely



Sauna paradise Holic



Golf resort Malacky Eurovalley Golf Park



Elementary school Schulzovy sady



Fitness Sokolov



# Laminated clothes lockers

Laminate clothes lockers are made from laminated chipboard with a thickness of 18mm in timeless decors. Simple and elegant design is complemented by cylindrical lock with two keys or any other locking solution. All edges are finished with 2mm ABS.

Stainless steel perforated grille allows circulation of the air together with offset doors.

Unique hinges Hettich Intermat ensure quite closing of the doors.

This locker will become an elegant part of your interior.



laminated maple mandal



laminated fleetwood champagne



laminated cherry-tree locarno



laminated oak bardolino



laminated oak corbridge



laminated pine

an extended range of decors can be found on page 90









<b>1-door</b>	
Height x width x depth (mm)	1970 x 420 x 500
Number of sections	1
Equipment	2 x shelf, 1 x rod
Weight net / gross (kg)	39 / 45
Order code	ILS-20-B45-XXX-XN



<b>2-door</b>	
Height x width x depth (mm)	1970 x 600 x 500
Number of sections	2
Equipment	4 x shelf, 2 x rod
Weight net / gross (kg)	62 / 69
Order code	ILD-20-B65-XXX-XN

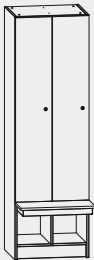

<b>2-door with a seat</b>	
Height x width x depth (mm)	1970 x 600 x 780
Number of sections	2
Equipment	2 x shelf, 2 x rod
Weight net / gross (kg)	57 / 65
Order code	ILD-20-B65-XXX-AN

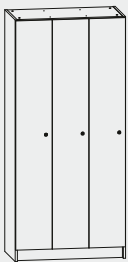

<b>3-door</b>	
Height x width x depth (mm)	1970 x 900 x 500
Number of sections	3
Equipment	6 x shelf, 3 x rod
Weight net / gross (kg)	86 / 91
Order code	ILT-20-B95-XXX-XN

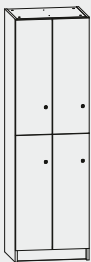

<b>4-box</b>	
Height x width x depth (mm)	1970 x 600 x 500
Number of sections	4
Equipment	4 x shelf, 4 x rod
Weight net / gross (kg)	59 / 66
Order code	ILC-20-B65-XXX-XN

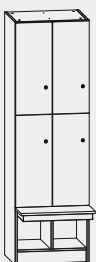

<b>4-box with a seat</b>	
Height x width x depth (mm)	1970 x 600 x 780
Number of sections	4
Equipment	4 x rod
Weight net / gross (kg)	58 / 66
Order code	ILC-20-B68-XXX-AN

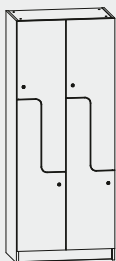

<b>„Z“ box</b>	
Height x width x depth (mm)	1970 x 800 x 500
Number of sections	4
Equipment	4 x rod
Weight net / gross (kg)	69 / 77
Order code	ILZ-20-B85-XXX-XN



<b>6-box</b>	
Height x width x depth (mm)	1970 x 900 x 500
Number of sections	6
Equipment	6 x shelf, 6 x rod
Weight net / gross (kg)	78 / 88
Order code	ILE-20-B95-XXX-XN



<b>8-box</b>	
Height x width x depth (mm)	1970 x 600 x 500
Number of sections	8
Equipment	-
Weight net / gross (kg)	59 / 66
Order code	ILF-20-B65-XXX-XN



<b>10-box</b>	
Height x width x depth (mm)	1970 x 800 x 500
Number of sections	8
Equipment	-
Weight net / gross (kg)	59 / 66
Order code	ILG-20-B85-XXX-XN





## Steel clothes lockers

Steel clothes lockers are made of quality steel with powder-coated finish. Powder-coating technology fully meets our customers' requirements. The paint is very resistant against chemical or mechanical damage. A rigid frame ensures stability of every locker. Reinforced doors can be opened almost up to 180° due to our unique hinges. Perforations in doors and frame ensure effective air-ventilation. Levelling feet are always included.

Lockers can be screwed together to create one compact unit.

Timeless design and high quality are the main features of Tritón lockers. They can be used in locker rooms of schools, sport facilities, hospitals, etc.

Standard colour range is RAL 7035 (light grey), RAL 5005 (blue), and RAL 9005 (black).

Other colours from RAL sampler are available upon request.

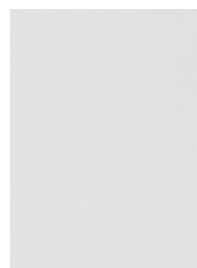

steel grey  
(RAL 7035)



steel blue  
(RAL 5005)



steel black  
(RAL 9005)





Solid frame construction



Air circulation system



Solid section divider



Reinforced door frame,  
unique hinges



Practical shelves



Levelling feet



<b>1-door</b>			
Height x width x depth (mm)	1525 x 420 x 500	1750 x 420 x 500	1970 x 420 x 500
Number of sections	1	1	1
Equipment	1 x shelf, 1 x rod	1 x shelf, 1 x rod	2 x shelf, 1 x rod
Weight net / gross (kg)	29 / 35	32 / 39	36 / 43
Order code	ISS-15-A45-XXX-X2	ISS-18-A45-XXX-X2	ISS-20-A45-XXX-X2

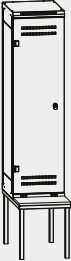

<b>1-door with a seat</b>		
Height x width x depth (mm)	1970 x 420 x 780	2195 x 420 x 780
Number of sections	1	1
Equipment	1 x shelf, 1 x rod	1 x shelf, 1 x rod
Weight net / gross (kg)	37 / 45	40 / 48
Order code	ISS-20-A48-XXX-A2	ISS-22-A48-XXX-A2



<b>2-door</b>			
Height x width x depth (mm)	1525 x 600 x 500	1750 x 600 x 500	1970 x 600 x 500
Number of sections	2	2	2
Equipment	2 x shelf, 2 x rod	2 x shelf, 2 x rod	4 x shelf, 2 x rod
Weight net / gross (kg)	44 / 51	50 / 57	57 / 63
Order code	ISD-15-A65-XXX-X2	ISD-18-A65-XXX-X2	ISD-20-A65-XXX-X2

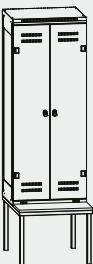

<b>2-door with a seat</b>		
Height x width x depth (mm)	1970 x 600 x 780	2195 x 600 x 780
Number of sections	2	2
Equipment	2 x shelf, 2 x rod	2 x shelf, 2 x rod
Weight net / gross (kg)	54 / 62	58 / 66
Order code	ISD-20-A68-XXX-A2	ISD-22-A68-XXX-A2

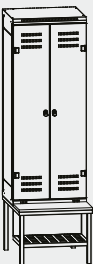

<b>2-door with a seat with integrated grate</b>		
Height x width x depth (mm)	1970 x 600 x 780	2195 x 600 x 780
Number of sections	2	2
Equipment	2 x shelf, 2 x rod	2 x shelf, 2 x rod
Weight net / gross (kg)	58 / 66	62 / 70
Order code	ISD-20-A68-XXX-R2	ISD-22-A68-XXX-R2



<b>3-door</b>		
Height x width x depth (mm)	1750 x 900 x 500	1970 x 900 x 500
Number of sections	3	3
Equipment	3 x shelf, 3 x rod	6 x shelf, 3 x rod
Weight net / gross (kg)	67 / 77	76 / 86
Order code	IST-18-A95-XXX-X2	IST-20-A95-XXX-X2



2-door locker, grey RAL 7035/blue RAL 5005



2-door locker with a bench, grey RAL 7035



1-door locker,  
grey RAL 7035/blue RAL 5005



3-door locker,  
grey RAL 7035/blue RAL 5005



3-door locker with a bench,  
grey RAL 7035/black RAL 9005



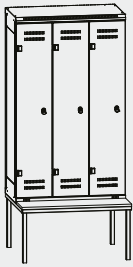

<b>3-door with a seat</b>		
Height x width x depth (mm)	1970 x 900 x 780	2195 x 900 x 780
Number of sections	3	3
Equipment	3 x shelf, 3 x rod	3 x shelf, 3 x rod
Weight net / gross (kg)	72 / 79	79 / 84
Order code	IST-20-A98-XXX-A2	IST-22-A98-XXX-A2



<b>4-box</b>			
Height x width x depth (mm)	1525 x 600 x 500	1750 x 600 x 500	1970 x 600 x 500
Number of sections	4	4	4
Equipment	4 x rod	4 x rod	4 x rod
Weight net / gross (kg)	48 / 55	52 / 58	57 / 63
Order code	ISC-15-A65-XXX-X2	ISC-18-A65-XXX-X2	ISC-20-A65-XXX-X2



<b>4-box with a seat</b>		
Height x width x depth (mm)	1970 x 600 x 780	2195 x 600 x 780
Number of sections	4	4
Equipment	4 x rod	4 x rod
Weight net / gross (kg)	58 / 64	61 / 69
Order code	ISC-20-A68-XXX-A2	ISC-22-A68-XXX-A2



<b>4-box with a seat with integrated grate</b>		
Height x width x depth (mm)	1970 x 600 x 780	2195 x 600 x 780
Number of sections	4	4
Equipment	4 x rod	4 x rod
Weight net / gross (kg)	62 / 68	65 / 73
Order code	ISC-20-A68-XXX-R2	ISC-22-A68-XXX-R2

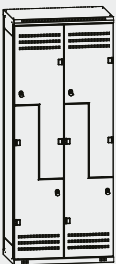

<b>„Z“-type</b>	
Height x width x depth (mm)	1970 x 800 x 500
Number of sections	4
Equipment	4 x rod
Weight net / gross (kg)	64 / 74
Order code	ISZ-20-A85-XXX-X2



<b>6-boxové</b>	
Height x width x depth (mm)	1970 x 900 x 500
Number of sections	6
Equipment	6 x rod
Weight net / gross (kg)	73 / 83
Order code	ISE-20-A95-XXX-X2



8-box	
Height x width x depth (mm)	1970 x 600 x 500
Number of sections	8
Equipment	-
Weight net / gross (kg)	54 / 61
Order code	ISF-20-A65-XXX-X2

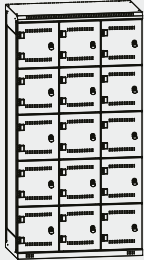

15-box	
Height x width x depth (mm)	1750 x 900 x 500
Number of sections	15
Equipment	-
Weight net / gross (kg)	94 / 104
Order code	ISO-18-A95-XXX-X2



4-box locker with a bench, grey RAL 7035/blue RAL 5005



15-box locker, grey RAL 7035/grey RAL 7035 and blue RAL 5005



Tritón Pardubice, spol. s r.o.



Tritón Pardubice, spol. s r.o.



Elementary School Pardubice – Polabiny, Npor. Eliáše



Agrarlandtechnik



Euro Bus





Neu Mitte Schule



AZ Herentals



Internationale Schule Hamburg



Vodovody a kanalizace Přebouč



Hotel Melia Wien



Dostihový spolek Pardubice



Elementary School and Kindergarten Chotíkov



APAG Elektronik s.r.o.



## Golf lockers

Golf lockers are designed for safe storage of golf bags, carts, and other equipment. A shelf for power distribution unit or a cart charger is located on the locker's side. A hole in the rear ensures easy wiring into the locker. Users will certainly appreciate the small box on the reinforced door for golf balls or other small items.

Perforation in the door and in the body serves for air-ventilation. Stored items are safely locked with high quality locks. Triton golf lockers can be placed in two levels.



Power distribution unit shelf



Opening for electric



steel grey  
(RAL 7035)

steel blue  
(RAL 5005)

steel black  
(RAL 9005)



**Golf lockers – steel**

Height x width x depth (mm)	1250 x 550 x 550	1250 x 825 x 550	1250 x 825 x 1100
Equipment	basket for golf balls and small items, shelf for a power distribution unit		
Weight net / gross (kg)	36 / 43	44 / 50	62 / 69
Order code	IGS-13-A55-XXX-XX	IGS-13-A85-XXX-XX	IGS-13-A80-XXX-XX

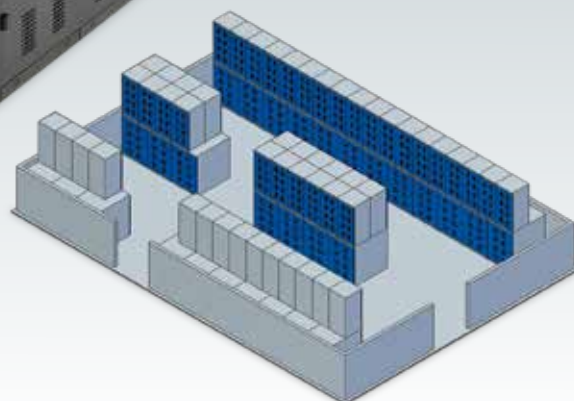
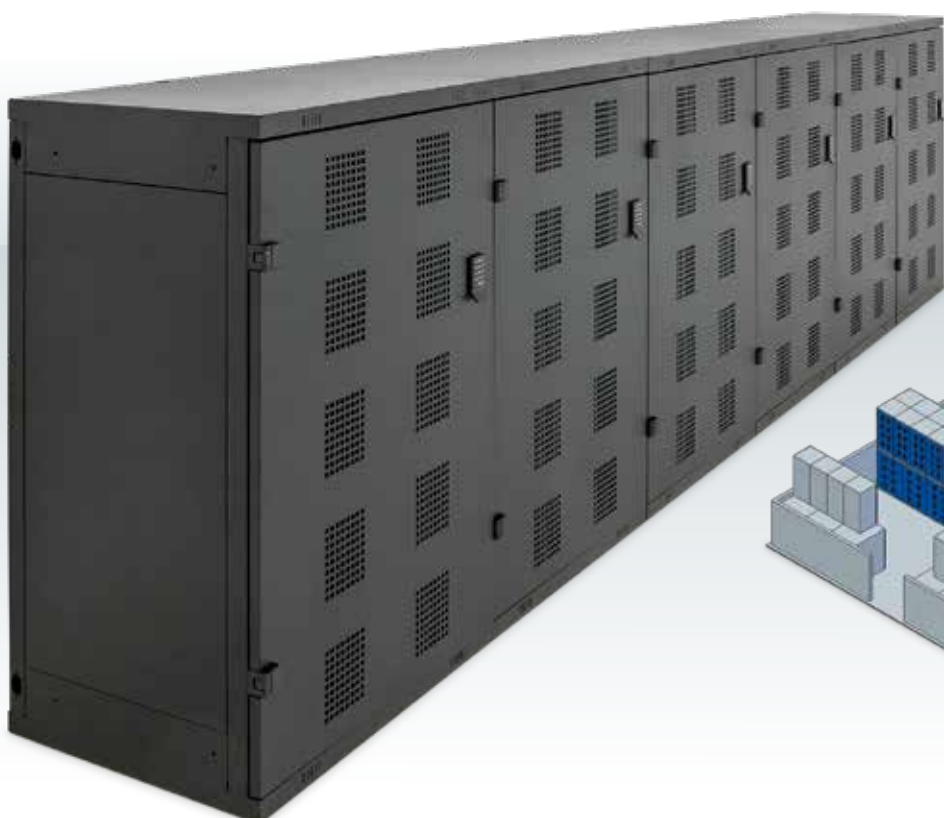

Your project visualisation  
can be provided upon request.





Migros Golfplatz Moossee



Golf Club Gams Werdenberg



Golf Club Pyšely



Golf resort Buchholz



Golf Mstětice



City & Country Golfclub Am Wienerberg



Les Bois



Golfplatz Clebronn



Golf Club Bad Rappenau



Golf club Pardubice - Lázně Bohdaneč







# Saddle locker

Saddle lockers are designed to store saddles and other equestrian equipment. Lockers are made of high quality zinc-coated steel with powder-coated finish. This combination ensures resistance to chemical or mechanical damage. Lockers can be screwed together to create one compact unit.

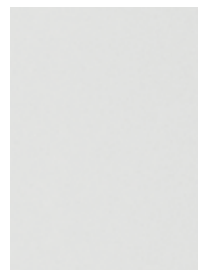

steel grey  
(RAL 7035)



steel blue  
(RAL 5005)

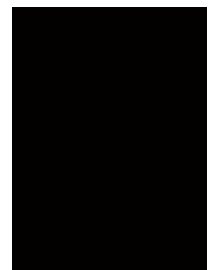

steel black  
(RAL 9005)

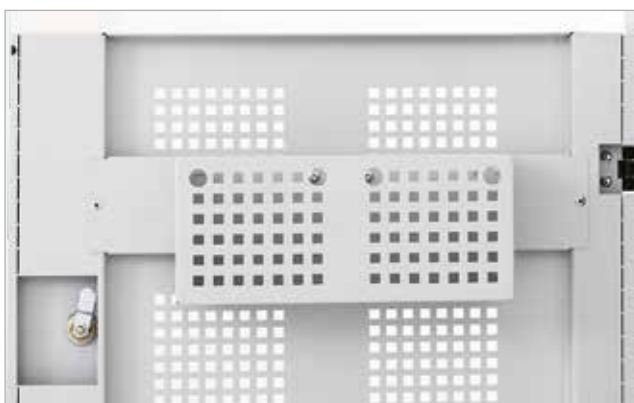



### Saddle locker

Height x width x depth (mm)	1100 x 600 x 600
Number of sections	1
Equipment	2 x saddle holder including a hook for a bridle, 2 x steel hanger for bridles, basket for small items
Weight net / gross (kg)	42 / 47
Order code	KSS-11-A66-XXX-X1







# Ball locker

Ball locker stores all kinds of balls and other sport equipment in gyms and sport facilities. Four high-adjustable shelves with raised edges ensure the balls will stay in the locker.

Ball lockers are made from laminate chipboard 18 mm thick which have one fixed shelf and two adjustable shelves for better flexibility. In case of needs we are able to deliver shelves separately. All edges are covered by ABS edge thick 2 mm.

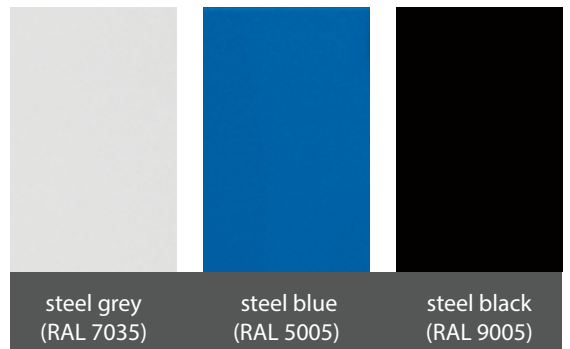

an extended range of decors can be found on page 90



Ball locker	steel	lamine
Height x width x depth (mm)	1970 x 900 x 400	2100 x 1200 x 600
Number of sections	1	1
Equipment	4 height-adjustable shelves, jersey rod	solid shelf, 2 adjustable shelves, turning lock Burg
Weight net / gross (kg)	70 / 75	135 / 143
Order code	IMS-20-A94-XXX-X1	YYAT18-0002-16 laminate oak corbridge







## Hockey box and multipurpose boxes

Hockey box is made of laminated chipboard and is designed for locker rooms in hockey arenas. However, it can be used elsewhere, where there is no need for standard lockers.

Hockey box is offered in two versions: with open or closed space under the seat. One lockable box with a slot for quick storage is included as well as two double hooks and two shelves.

The hockey box is designed for up to two persons.



lamine maple  
mandal



lamine fleetwood  
champagne



lamine  
cherry-tree locarno



lamine  
oak bardolino



lamine  
oak corbridge



lamine  
pine

an extended range of decors can be found on page 90



Hockey box and multipurpose boxes		
Height x width x depth (mm)	1970 x 800 x 600	1970 x 800 x 600
Number of sections	1	1
Equipment	2x shelf, 1x box, 2x double hooks, open space under the bank (seat)	2x shelf, 1x box, 2x double hooks
Weight net / gross (kg)	63 / 68	67 / 74
Order code	IAH-20-B86-XXX-X0	IAH-20-B86-XXX-X1





The HPL universal box is made from high pressure laminate which is extremely durable to destruction and ideal for all the professional and semi-professional clubs. Two variants are proposed.

Player variant with a width of 800 mm and goalkeeper's version with a width of 1000 mm. As this is an exclusive affair, we offer a wide range of decors to meet the demands of all clubs on their color combinations.



HPL hockey box		
Height x width x depth (mm)	2180 x 800 x 650	2180 x 1000 x 650
Equipment	2x shelf, 3x hooks, storage space under the seat	2x shelf, 3x hooks, storage space under the seat
Weight net / gross (kg)	90 / 96	107 / 113
Order code	NPAT18-0002-11 hockey player	NPAT18-0002-01 hockey goalkeeper









Fredericia Idrætscenter



HC Warnsdorf



HC Dynamo Pardubice



HC AZ HAVÍŘOV



HC Dynamo Pardubice





Vendsyssel FF



Vendsyssel FF



Vendsyssel FF



HC Poděbrady



Umeå FC



## Ski and snowboard lockers

Ski and snowboard lockers are designated for ski equipment storage in hotels, pensions and ski-depots in ski areas.

The lockers are characterised by welded steel frame, which is powder coated. Back panel is ready to be equipped with efficient drying system.

Special perforation in the door and back side provides air circulation inside the locker.

Option with 2/3 shelf allows you to put in longer objects to use the full height of the locker.

The lockers can be equipped with zinc-coated drip tray or grid.

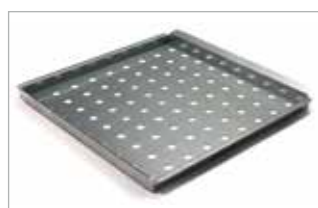
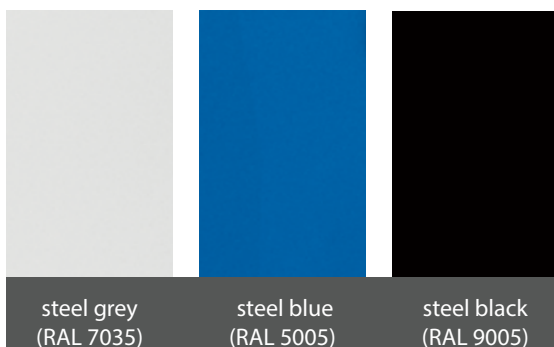

- NLAT20-0005-66 – Removable Drip Tray SKI 320x600, oblique
- NLAT20-0005-67 – Removable Drip Tray SKI 520x600, oblique
- NLAT20-0005-68 – Removable base grid SKI 320x600
- NLAT20-0005-69 – Removable base grid SKI 520x600



### Ski and snowboard lockers

Height x width x depth (mm)	2155 x 320 x 600	2155 x 520 x 600
Number of sections	1	1
Equipment	1 x shelf	1 x shelf
Weight net / gross (kg)	44 / 49	54 / 58
Order code	LSS-21-A36-XXX-X2 - zinc-coated	LSS-21-A56-XXX-X2 - zinc-coated
Order code 2/3 shelf	LSS-21-A36-XXX-X3 - zinc-coated	LSS-21-A56-XXX-X3 - zinc-coated

## Drying systems

The drying systems for shoes, ski boots and rubber boots operate on the continuous circulation of hot air, which is blown onto the drying objects in the locker. The air temperature is around 45°C (ambient temperature 15°C - 25°C) and is perfect for fast, hygienic and safe drying. Every dryer has an analogue timer with settings for 1-120 minutes of operation.

These drying systems have a wide range of applications in a variety of businesses and organisations such as fire stations, chemical laboratories, construction companies, industrial companies, agricultural facilities, hotels, cottages, fishing clubs, army facilities, police stations, sports clubs and many more.

The purpose of use: boot dryer, ski boots dryer, rubber boots dryer, drying locker.







Hotel Harmony



Bergbahnen Belalp Blatten



Deep Pec pod Sněžkou



Hause Chappelle in Ulrichen



Hotel Svatý Vavřinec



Orea Resort Horal



Orea Resort Horal



Orea Resort Horal



Grandhotel Hradec, Pec pod Sněžkou





# Fire lockers

## and lockers for rescue services

Clothes lockers especially made for firefighters and rescue services.

Lockers have a welded body made of 1 mm steel. Their open construction allows immediate access to the stored clothing

whenever needed.

Feet can be purchased separately, as well as a special tilting helmet holder. Holder can be easily pulled and the helmet removal is simple.



**Order code:** IAI-02-XXX-IXX-T1



**Order code:** IAI-01-XXX-XXX-X1

Steel red  
(RAL 3000)





**IPA**



**IPB**

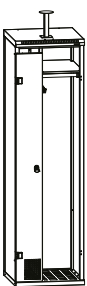

<b>IPA</b>	
Height x width x depth (mm)	1780 x 500 x 500
Number of sections	2
Equipment	2 x shelf, rod, helmet holder, 3 x steel clothes hooks
Weight net / gross (kg)	48 / 53
Order code	IPA-18-A55-IIR-X1 (mechanical code lock), IPA-18-A55-IIC-X1 (cylindrical lock)

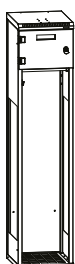

<b>IPB</b>	
Height x width x depth (mm)	1780 x 400 x 500
Number of sections	1
Equipment	1 x lockable box, rod, 3 x steel clothes hooks, special air system between lockers (perforation in side panels)
Weight net / gross (kg)	41/46
Order code	IPB-18-A45-IIC-X2 (cylindrical lock), IPB-18-A45-IIR-X2 (mechanical code lock)



**IPC**



**IPD**

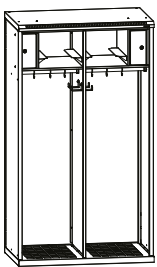

<b>IPC</b>	
Height x width x depth (mm)	1780 x 1000 x 600
Number of sections	2
Equipment	chrome rod with hooks, inner helmet holder, belt hooks, lockable storing boxes
Weight net / gross (kg)	71 / 78
Order code	IPC-18-A16-IIR-D2 (mechanical code lock), IPC-18-A16-IIC-D2 (cylindrical lock)

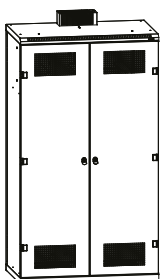

<b>IPD</b>	
Height x width x depth (mm)	1780 x 1000 x 600
Number of sections	2
Equipment	chrome rod with hook, inner helmet holder, belt hooks, lockable storing boxes, dryer (energy consumption 500 W/H)
Weight net / gross (kg)	95 / 101
Order code	IPD-18-A16-IIC-D2(cylindrical lock), IPD-18-A16-IIR-D2 (mechanical code lock)



**IPO**



**IPS**

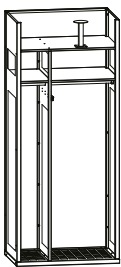

<b>IPO</b>	
Height x width x depth (mm)	1780 x 750 x 500
Number of sections	2
Equipment	rod, helmet holder, 3x steel clothes hooks, special perforation
Weight net / gross (kg)	49 / 55
Order code	IPO-18-X75-IIX-X1

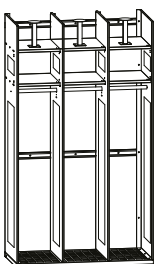

<b>IPS</b>		
Height x width x depth (mm)	1780 x 1000 x 500	
Number of sections	3	
Equipment	rod, 3x helmet holder, special perforation	
Weight net / gross (kg)	48 / 55	41 / 48
Order code	IPS-18-X15-IIX-ZX	IPS-18-X15-IIX-DX without one side wall

IPS lockers are made to be fixed to the wall and are delivered unassembled in packaging of ca 180 x 350 x 550 mm.





**IPE – X1**

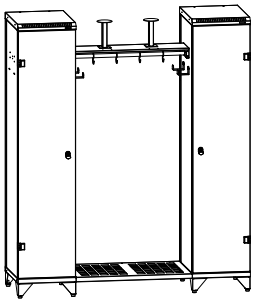

<b>IPE (X1)</b>	
Height x width x depth (mm)	1780 x 1600 x 500
Number of sections	2
Equipment	chrome rod with hooks, helmet holder, 2 clothes/belt hooks, galvanized steel grate in locker: chrome rod, 2 clothes hooks, 3 doublehooks, 2 shelves
Weight net / gross (kg)	100/ 106
Order code	IPE-18-A85-IIC-X1 (cylindrical lock) IPE-18-A85-IIR-X1 (mechanical code lock)





**IPE – X2**



**IPF**

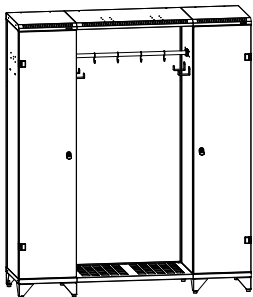

<b>IPE (X2)</b>	
Height x width x depth (mm)	1780 x 1600 x 500
Number of sections	2
Equipment	1 chrome rod, 2 clothes hooks, galvanized steel grate for shoes, belt hook, preparation for helmet holder on top of the locker 1 lockable locker with chrome rod, 2 clothes hooks, 3 doublehooks, 2 shelves, special perforation
Weight net / gross (kg)	113 / 119
Order code	IPE-18-A85-IIC-X2 (cylindrical lock) IPE-18-A85-IIR-X2 (mechanical code lock)

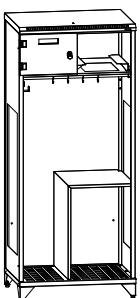

<b>IPF</b>	
Height x width x depth (mm)	1780 x 800 x 600
Number of sections	2
Equipment	1 lockable box, inner helmet holders, chrome rod, 4 clothes hooks, 2 hooks on side inside the locker
Weight net / gross (kg)	62 / 68
Order code	IPF-18-A86-IIC-X1 (cylindrical lock) IPF-18-A86-IIR-X1 (mechanical code lock)



Feuerwehr Buochs Ennetbürgen



Freiwillige Feuerwehr Erpfting



Freiwillige Feuerwehr Munchehof



Feuerwehr Wallenwil/Eschlikon



ZOO Hluboká nad Vltavou





Bayerisches Rotes Kreuz



Bayerisches Rotes Kreuz



Nordic Lockers



Van Akelyen



Brandweer Zandhoven



# Key lockers

**Steel key lockers** with hardened glass door are used for perfect key management. The locker can be easily mounted to the wall. Hooks are made of steel.

**Laminated chipboard key locker** is made in maple decor and carries hooks made of steel. The locker is fitted with cylindrical lock for safe key-storage.

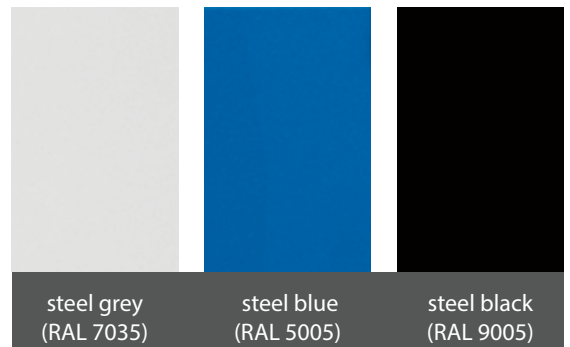

an extended range of decors can be found on page 90



### Key lockers

Height x width x depth (mm)	670 x 370 x 105	670 x 620 x 105	990 x 620 x 105
Number of hooks	50 hooks (5 x line / 10 pcs)	100 hooks (5 x line / 20 pcs)	160 hooks (8 x line / 20 pcs)
Weight (kg)	8	12	18
Order code	IAK-06-C41-XXX-X1	IAK-06-C61-XXX-X1	IAK-09-C61-XXX-X1



### Laminated chipboard key locker

Height x width x depth (mm)	615 x 310 x 125	615 x 560 x 125	950 x 560 x 125
Number of hooks	50 hooks (5 x line / 10 pcs)	100 hooks (5 x line / 20 pcs)	160 hooks (8 x line / 20 pcs)
Weight (kg)	8	13	18
Order code	LAK-06-B31-CAA-X1	LAK-06-B51-CAA-X1	LAK-09-B51-CAA-X1





# Cloakroom seats

Steel sheet and laminated chipboard combination

Cloakroom seats for plants, gyms, schools, and sport facilities.

The frame is made of sturdy 30 x 30 mm steel profiles and the seat is laminated chipboard with 2mm ABS edging.

Feet are fitted with plastic gliders. Cloakroom seats can be made in versions with hooks.



If requested, the frame can be adjusted for storing shoes.



steel grey  
(RAL 7035)

steel black  
(RAL 9005)



lamine maple  
mandal



lamine fleetwood  
champagne



lamine  
cherry-tree locarno



lamine  
oak bardolino



lamine  
oak corbridge



lamine  
pine

an extended range of decors can be found on page 90



#### One-sided cloakroom bench with hooks

Height x length x depth (mm)	1800 x 1200 x 430	1800 x 1500 x 430	1800 x 2000 x 430
Number of hooks	8	10	13
Weight net / gross (kg)	67	75	89
Order code	ITV-04-X01-XXX-X3	ITV-04-X02-XXX-X3	ITV-04-X03-XXX-X3

#### Double-sided cloakroom bench with hooks

Height x length x depth (mm)	1800 x 1200 x 430	1800 x 1500 x 430	1800 x 2000 x 430
Number of hooks	16	20	32
Weight net / gross (kg)	111	121	150
Order code	ITV-08-X01-XXX-X3	ITV-08-X02-XXX-X3	ITV-08-X03-XXX-X3



#### Cloakroom seat

Height x length x depth (mm)	460 x 1200 x 350	460 x 1500 x 350	460 x 2000 x 350	460 x 2000 x <b>550</b>
Weight (kg)	14	18	25	26
Order code	ITL-04-X03-XXX-X2	ITL-04-X04-XXX-X2	ITL-04-X05-XXX-X2	ITL-04-X01-XXX-X2



**NEW**

## Whole laminated wardrobe bench

The whole laminated bench is made of durable laminated chipboard with a thickness of 36 mm with a 2 mm ABS edge.

Thanks to the materials used and the design, these benches are especially suitable for spaces where high demands are placed on the overall design of the dressing room.



XXXXX			
Height x length x depth (mm)	460 x 600 x 350	460 x 800 x 350	460 x 1000 x 350
Weight (kg)	14	16	18
Order code	ILL-04-X01-XXX-X1	ILL-04-X02-XXX-X1	ILL-04-X03-XXX-X1



laminate maple mandal

laminate fleetwood champagne

laminate cherry-tree locarno

laminate oak bardolino

laminate oak corbridge

laminate pine





**NEW**

# Design self-watering flowerpot

**Environment:** Exterior / Interior  
**Colour:** antracit RAL 7016  
**Material:** zinc coated steel treated with facade powder coating  
**Dimensions:** 875 x 850 x 300 mm (W x H x D)  
**Included:** 3x self – watering plastic set, 2x wheels, 2x rectifying feet  
**Weight:** 23 kg (including plastic inner liners)

Plastic inner liner with self-watering set

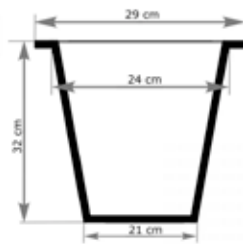

**This set consists of:**  
 – from the inner plastic liner  
 – double bottom (partitions)  
 – water status indicators

High-quality and stable plastic is used for the inserts, so they can be used indoors and outdoors.

**Inner flower liners:**  
 3 x self-watering plastic set in black with water level indicator.

**Easy handling:**  
 2 wheels for movement and 2 rubber feet to prevent spontaneous movement.

**Also can be ordered:**  
 Set of sheet metal profiles for anchoring the flowerpot (including connecting).



Antracite  
RAL 7016



# Shelf racks

## Shelf racks

Universal mounted rack for archives, workshops and warehouses.  
Shelves can be adjusted, each by 45 mm.  
Loading: 100 kg  
Max. loading capacity: 500 kg

It comes disassembled into individual components.

## Welded shelf racks - steel / laminated chipboard

Shelves made of 18 mm thick laminated chipboard and fitted into a steel frame. We recommend the shelf rack to be mounted to a wall.  
Loading capacity: 75 kg  
Max. loading capacity: 450 kg

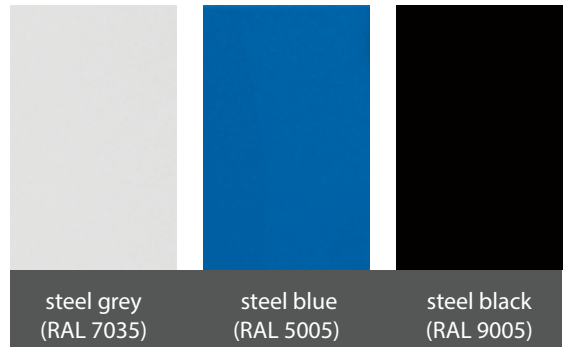

an extended range of decors can be found on page 90



<b>Shelf racks</b>				
Height x width x depth (mm)	2000 x 1000 x 400	2000 x 1000 x 500	2000 x 1000 x 400	2000 x 1000 x 500
Surface treatment	zinc-coated	zinc-coated	colour	colour
Equipment	5 x shelf	5 x shelf	5 x shelf	5 x shelf
Weight net / gross (kg)	38 / 39	44 / 45	29 / 30	34 / 35
Order code	IAR-20-X14-XXX-X1	IAR-20-X15-XXX-X1	IAR-20-X14-CCX-X1	IAR-20-X15-CCX-X1

<b>Welded shelf racks - steel / laminated chipboard</b>	
Height x width x depth (mm)	2000 x 1000 x 500
Surface treatment	laminate
Equipment	6 x shelf
Weight net / gross (kg)	63 / 69
Order code	IDR-20-X15-XXX-X1







# Workbenches

**Universal and flexible workbench for workshops, school classrooms, warehouses and garages.**

Adjustable feet for adjusting the height of the working desk in 50 mm increments from 655 mm up to 1005 mm.

**Supplied table lengths (mm):** 750, 1200, 1500, 1700, 2000

**Depth for all table lengths (mm):** 700

**Table loading capacity (kg):** 500 at even load

**Workspace:** solid beech battenboard with a thickness of 40 mm, chamfered top edges

**Fixed profiled base:** welded from steel profiles, rear traverse for higher rigidity

**Surface treatment of metal profiles:** powder coating - gray RAL 7035





Workbenches					
Height (mm)	750	1 200	1 500	1 700	2 000
Width x depth (mm)	655 – 1005 x 700	655 – 1005 x 700	655 – 1005 x 700	655 – 1005 x 700	655 – 1005 x 700
Order code					
RAL7035	CXAT20-0056-05	CXAT20-0056-04	CXAT20-0056-03	CXAT20-0056-02	CXAT20-0056-01
RAL 5005	UXAT20-0056-05	UXAT20-0056-04	UXAT20-0056-03	UXAT20-0056-02	UXAT20-0056-01

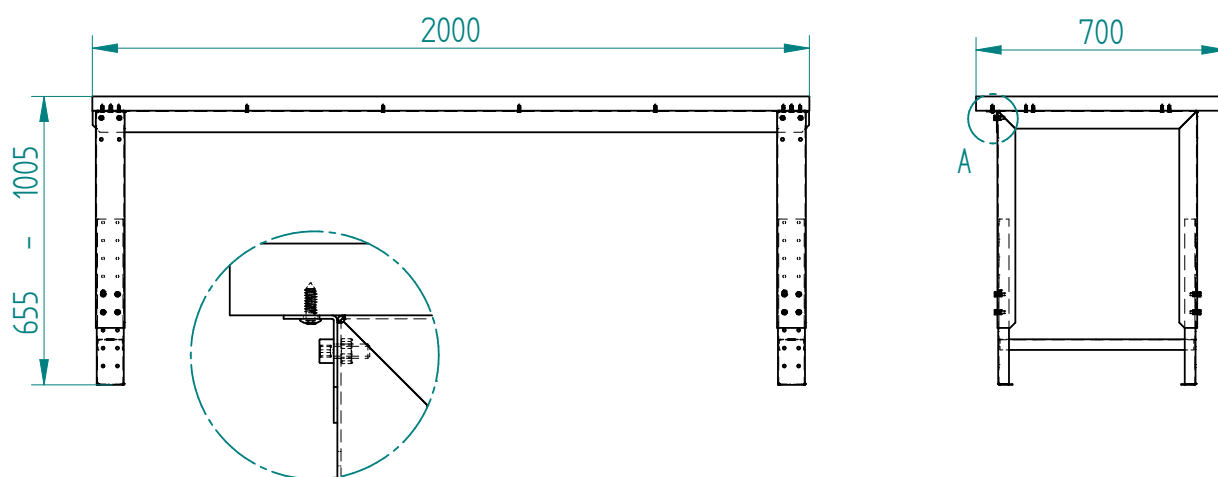



# Container

## Container with door and shelf

1 x shelf

Door in RAL 5005 with magnets, cabinet RAL 7035.

Opening the door from left to right and vice versa can be easily interchanged.

Internal adjustable shelf with 21.5 mm grille, fastened with 4 M5 screws, upper chamber light from 105 to 190 mm.

## Container with drawers

4 x socket

1 x upper drawer - internal height 80 mm

3 x bottom drawer - internal height 130 mm

telescopic drawer extension - 100%

load capacity of drawers 45 kg

Powder coating of the container varnish gray / blue, RAL 7035/5005.

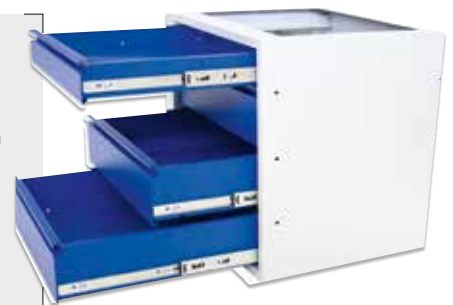

	Order Code	Dimensions W x H x D	Weight (kg)	Color
Workshop table container 4 x drawer	BXAT20-0056-14	570 x 600 x 550	40	black skeleton, black sockets
Workshop table container 4 x drawer	CXAT20-0056-14		40	gray skeleton, gray drawers
Workshop table container - door	CUAT20-0056-20		26	gray skeleton, blue door

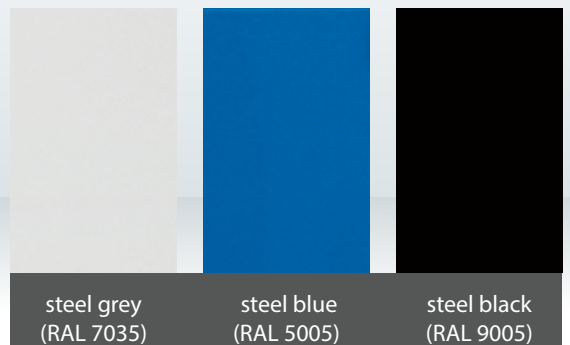





## Additional steel production and cooperation

### Mobile patient locker

The locker is fitted with a lockable box to store personal belongings.

It is also equipped with two handles and four wheels (two with brakes) for easy manipulation.

Easy cleaning is ensured by the smooth finish.





### Multipurpose storage box

The multipurpose storage box has been designed to store mainly small items such as wallets, cell phones and other valuables that you want to keep safe during any activities. It comes with a Burg lock that ensures trouble-free security so you can store away your personal belongings without any concerns.



### Referee table

The laminate referee table is suitable for any sport venue. It has a spacious table top containing a grommet allowing easy access to power for electronic devices. Its wheels with brakes ensure easy handling.



## Shoe locker

2-door shoe locker intended to be placed under seats of clothes lockers. The boxes can be put one on each other and fix them with screws.

**Dimensions:** 410 x 512 x 600 mm

**Use:** intended to be placed under seats of clothes lockers

**Locking:** 2x cylindrical lock with 2 keys (possibility of turning lock for padlock)

**Frame:** welded with perforation

**Weight:** 14 kg

**Order code:** IAB-04-C56-XXX-X1



## Light frames



## Steel bedside cabinets





### Material

The wall with modules is made of high quality powder coated steel sheet with a smooth surface. The surface is very easy to maintain and durable.

### Installation

Easy assembly by simply sliding the hooks onto the the back of the boxes into the holes in the main plate and secured with a screw joint.



### USAGE:



HEALTH CARE



INDUSTRY



GOVERNMENT



SCHOOL



BLOCKS OF FLATS

# Multifunctional storage wall

for flyers, keys, medications, mail, defibrillator

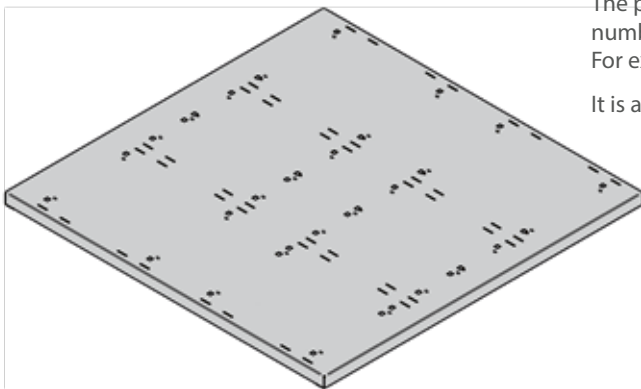

The plate allows easy fixing of various types of boxes in different number combinations.

For example, it can contain only 4 mail boxes and 4 flyer modules.

It is always supplied only in a specific combination.

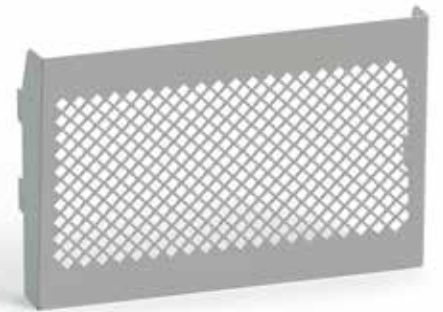

### Colour

Hanging modules and plate are supplied in two-colour combination grey/blue or grey/black.

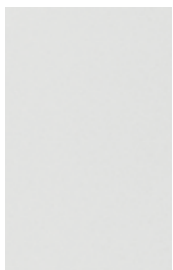

grey  
(RAL 7035)

blue  
(RAL 5005)

black  
(RAL 9005)

## Modules:

FOR FLYERS  
IUS-PR-XXX-XXX-X1

### Dimensions

width 285 mm  
height 190 mm  
depth 54 mm

### Weight

0,46 kg

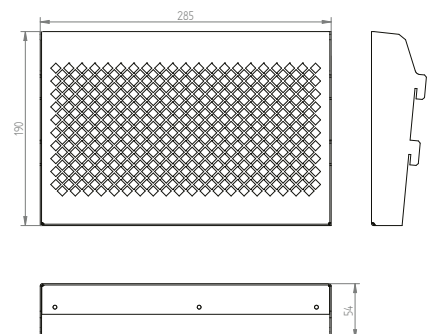

FOR KEYS  
IUS-04-K38-XXX-X1

**Dimensions**

width 300 mm  
height 400 mm  
depth 60 mm

**Weight**

3,96 kg

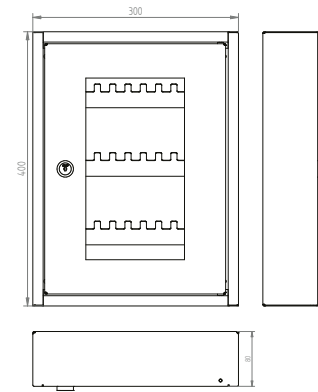

FOR MEDICATIONS  
IUS-04-L31-XXX-X1

**Dimensions**

width 300 mm  
height 400 mm  
depth 120 mm

**Weight**

4,00 kg

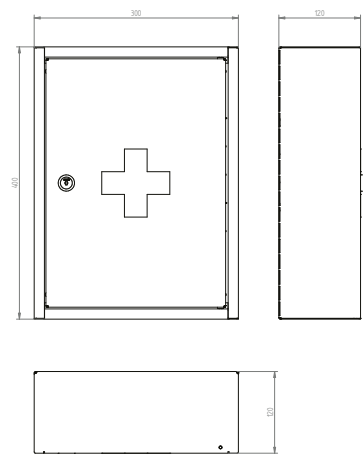

FOR MAIL  
IUS-04-P38-XXX-X1

**Dimensions**

width 300 mm  
height 400 mm  
depth 60 mm

**Weight**

3,26 kg

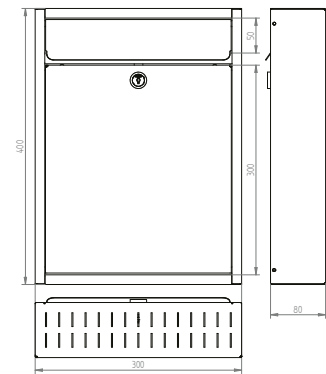

FOR A DEFIBRILLATOR  
IUS-04-D52-XXX-X1

**Dimensions**

width 500 mm  
height 400 mm  
depth 200 mm

**Weight**

8,19 kg

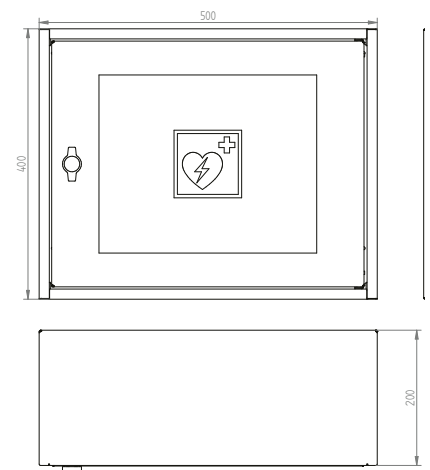

Mail box for smart pickup larger parcels from shipping companies without the presence of the recipient.

The box is locked with a numerical code lock allowing the courier to securely deposit of the parcel using the unique code provided by the recipient.

The box is available in 3 sizes.

All boxes are equipped with levelling feet and holes in the back wall for anchoring to the wall.



**ANTI-Covid  
PROGRAM**

## Mail box

Optionally, a digital lock can be installed that can be touch-sensitive with up to an 8-digit code, or touch-sensitive with code and fingerprint reader + Bluetooth for remote control via an app on your mobile device.



### Colour

The mail box can be ordered in one colour or two-colour combination according to the pattern.

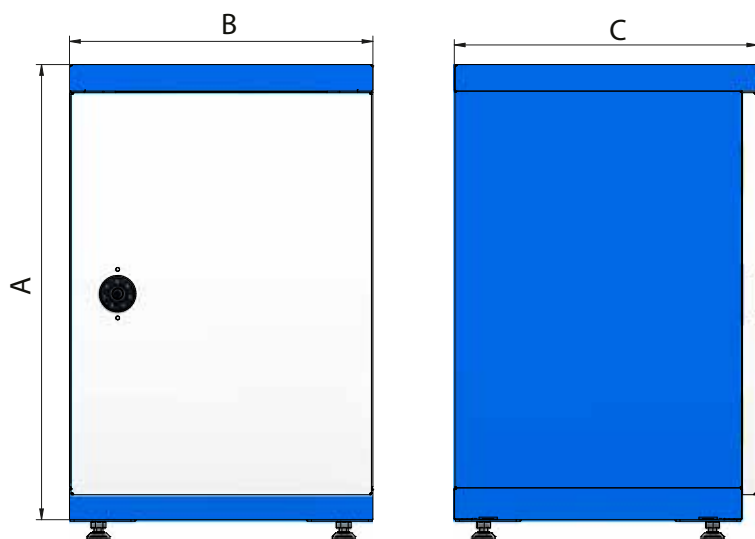
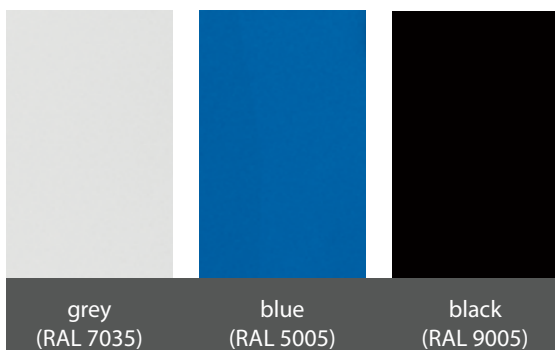

type	A	B	C	weight (kg)
	(mm)			
IBP-06-A44-XXX-X1	600	400	400	13
IBP-06-A54-XXX-X1	650	500	450	16,21
IBP-10-A66-XXX-X1	1000	600	650	28,54



Použití:



HEALTH CARE



INDUSTRY



GOVERNMENT



SCHOOL



BLOCKS OF FLATS

Fully automatic disinfectant dispenser with a motion sensor.

The base of the stand is made of sheet metal thickness 4 mm, stand profile made of sheet metal thickness 2 mm, welded construction is non-detachable.



ANTI-Covid  
PROGRAM

# Stand for Disinfectant Dispenser

Order Code: IDS-14-X43-XXX-X1

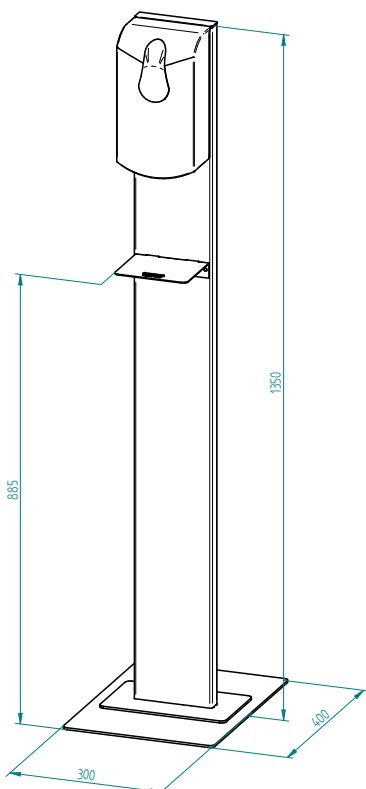

Dimensions:  
width 300 mm  
height 1350 mm  
depth 400 mm

Weight:  
10,48 kg

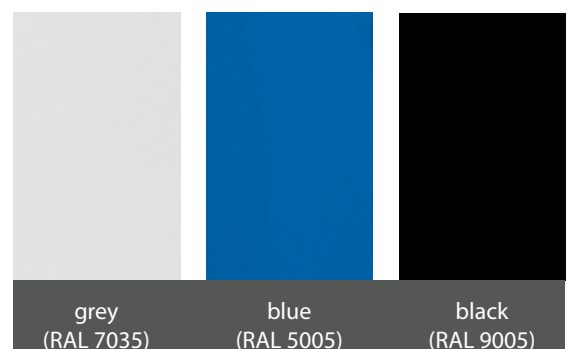

grey  
(RAL 7035)

blue  
(RAL 5005)

black  
(RAL 9005)

Usage::



HEALTHCARE



INDUSTRY



GOVERNMENT



SCHOOL



BLOCKS OF  
FLATS

There are two types to choose from disinfectant dispensers : manual or fully automatic with a motion sensor.

Module for the graphic allows you to insert and easily exchange information leaflets in A4 format.



# Hygienestand

including waste basket

**with preparation for flexible installation of different types of modules:**

Module for the graphic

Module for paper towels

Module for the face masks

Module for tissues or gloves

Disinfectant dispenser

Hanging modules and plate are supplied in two-colour combination grey/blue or grey/black.

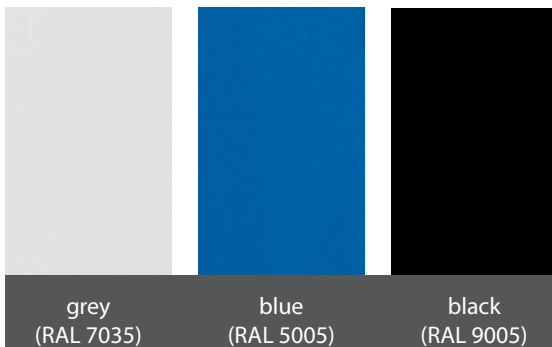

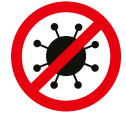

**ANTI-Covid  
PROGRAM**

# Modules

FOR PAPER TOWELS  
IDS-PR-XXX-XXX-P4



FOR TISSUES OR GLOVES  
IDS-PR-XXX-XXX-P2



FOR THE FACE MASKS  
IDS-PR-XXX-XXX-P1

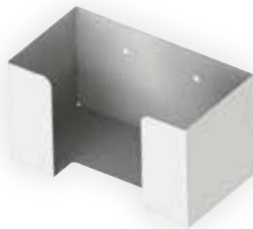

FOR THE GRAPHIC  
IDS-PR-XXX-XXX-P3



The plate allows easy fixing of modules with the included screws and nut into the prepared holes.

## DISINFECTANT DISPENSER



Manual dispenser  
Merida TOP -Spray



Automatic dispenser  
AUTOMATIC Merida ONE

STAND INCLUDING WASTE BASKET  
IDS-16-X45-XXX-X1



**Dimensions:**  
width 400 mm  
height 1600 mm  
depth 500 mm  
**Weight:**  
16,2 kg including waste basket

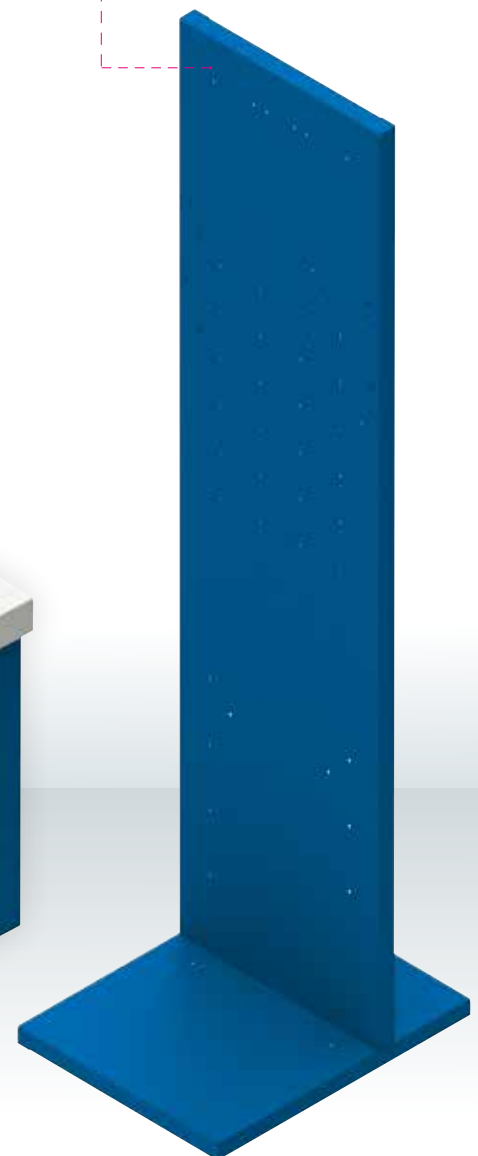





# Accessories

Our customers can choose from a wide variety of locker accessories.

## Shelves - Steel, Laminate

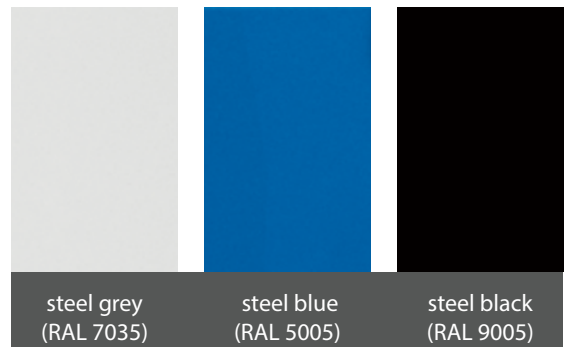

an extended range of decors can be found on page 90

## Plastic shoe pad

**Dimensions:** 270 x 345 mm  
IZN-PV-X23-XXX-X1



## Hook „S“

IZN-SS-X03-XXX-X1 - black plastic  
IZN-SS-X07-XXX-X2 - steel

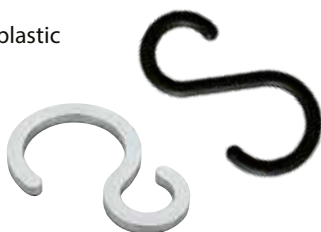

## Metal hook „9“

IAI-06-XXX-ZXX-X1



## Power distribution units

DIN: RAB-PD-X91-C1  
ČSN: RAB-PD-X90-C1



## Roof 15°

IAN-01-XX5-XXX-X1



## Levelling feet

included in a supply



## Connecting set

RAX-MS-X70-X1



## Key number tags

**Key numbering 01-50:**

IZN-SS-X02-XXX-X2

**Key numbering 001-100:**

IZN-SS-X02-XXX-X3

**Stainless steel**

**key numbering 001-100:**

IAI-03-XXX-NXX-X11



## Self-adhesive label

IZN-SS-X01-XXX-X2 - blue

IZN-SS-X01-XXX-X3 - black





# Locks

**Digilock®**

Company Digilock has been estimated 1981 in California. Nowadays is proudly on quality workmanship that simplifies security and improves user experience through innovation, quality and design for which is sought.

**BURG®**

BURG represents the fourth generation of the family business, whose history goes back to 1890, when the first padlock has been made. Today BURG is a modern supplier of locks for a variety of applications and one of the leading European manufacturers of locking systems. Our specialization are the mechanical and electronic locks for metal and wooden furniture.

**Metra.si**

Metra is a comprehensive supplier of online locking solutions including readers, touch screens, bar codes, QR codes and software services.

**ACS  
Solution**

ACS Solution specializes in comprehensive supplies, especially in the field of electronic access systems for hotels, spas, sports centers, apartment buildings, production halls, health and education facilities.



## Digilock®



### Digilock AXIS Keypad

#### Digilock AXIS Keypad Slim

The elegant appearance of the lock Digilock brings a clean design with solution for your locking. The lock is keypad operated with either a fixed or multi-user 4 digit code. This eliminates the necessity of keys, smart bracelets, keychains and cards. Also available in slim version.



### Digilock AXIS RFID

#### Digilock AXIS RFID Slim

The elegant appearance of the lock Digilock brings a clean design with solution for your locking. Access with cards or chip bracelets. The lock is RFID operated with either a assigned or free use. Also available in slim version.



### Digilock Cue Keypad

The lock is keypad operated with either a fixed or multi-user 4 digit code. This eliminates the necessity of keys, smart bracelets, keychains and cards.



### Digilock Cue RFID

Locks are operated by card or chip bracelet. This lock is battery powered and ensures solid security. The lock is RFID operated with either a assigned or free use.



### Digilock SOLA Keypad

Keypad operated with a 4-digit custom code. This lock is battery powered and ensures solid security. This eliminates the necessity of keys, smart bracelets, keychains and cards. Locks can be mounted in vertical or horizontal position.



### Digilock SOLA RFID

Locks are operated by card or chip bracelet. This lock is battery powered and ensures solid security. The lock is RFID operated with either an assigned or free use. Can be mounted in vertical or horizontal position.



**BURG®**

### Cylindrical lock Burg - for steel

Locking fixes the door in its central part. As a standard, locks are equipped with two steel keys. Locks can be equipped with a master key system (master key is universal for locks in steel and laminated chipboard as well).

**Order code:** IZN-ZK-X24-XXX-X1 - right, left lock  
 IZN-ZK-X08-XXX-X1 - master key



### Cylindrical lock Burg - for laminated chipboard

Locking fixes the door in its central part. As a standard, locks are equipped with two steel keys. Locks can be equipped with a master key system (master key is universal for locks in steel and laminated chipboard as well).

**Order code:** IZN-ZK-X06-XXX-X1 - right lock  
 IZN-ZK-X07-XXX-X1 - left lock  
 IZN-ZK-X08-XXX-X1 - master key



### Turning lock Burg

Locking with a turning clamp; a padlock is used to fix the lock in the locked position. Recommended diameter of the pad lock shackle is 6 mm.

**Order code:** IAZ-ZK-X67-XXX-X1 - right lock  
 IAZ-ZK-X66-XXX-X1 - left lock



### Safety turning lock Burg

Locking with a turning clamp; a padlock is used to fix the lock in the locked position. Recommended diameter of the pad lock shackle is 6 mm. After inserting the padlock shackle, the safety lock spins freely and prevents the forcible spinning of the lock in the assembly hole.

**Order code:** IAZ-ZK-X53-XXX-X1





## Mechanical code lock Burg sPinLock 510

This mechanical code lock has a 4-digit code locking system with the option of a master key. We recommend using this lock in places where the users do not change very often (lockers for fire fighters, golf lockers).

**Order code:** IZN-ZK-A20-XXX-X1 - right lock  
 IZN-ZK-A21-XXX-X1 - left lock  
 IZN-ZK-A22-XXX-X1 - master key



## Mechanical code lock Burg

This mechanical code lock has a 4-digit code locking system with the option of a master key. We recommend using this lock in places where the users do not change very often (lockers for fire fighters, golf lockers).

**Order code:** IZN-ZK-X26-XXX-X1 - right lock  
 IZN-ZK-X25-XXX-X1 - left lock  
 IZN-ZK-X22-XXX-X1 - master key



## Coin lock Burg

This lock is designed to accept € 1 coins. Another coin value can be requested as well. The key remains blocked in the lock until the coin is inserted and then the locker is locked. After unlocking, the coin is released and returned or held in a money collecting box and the key remains blocked in the lock again. Coin locks can be equipped with a master key.

**Order code:** IZN-ZK-X11-XXX-X1 - right lock for € 1  
 IZN-ZK-X12-XXX-X1 - left lock for € 1  
 IZN-ZK-X13-XXX-X1 - master key



## Burg Combi Pad

Keypad operated with a 4-digit or 6-digit custom code. Sturdy full metal anti-vandal lock. Water resistant. Battery lifetime is 60.000 locking cycles. Master key is replaced by master code system.

**Objednací kód:** IZN-ZK-X29-XXX-X1 - right lock  
 IZN-ZK-X30-XXX-X1 - left lock



## Burg Corona

Lock is operated by a card or any chip. It is compatible with systems based on 125 kHz frequency or Mifare technology. The lock includes two batteries, LED back light and can be programmed as single or multi-user.

**Order code:** IAZ-ZK-X60-XXX-X1 - lock for laminated chipboard  
IAZ-ZK-X59-XXX-X1 - lock for steel



## ACS 19-HU

Locks ACS 19-HU offer assigned or free use. Almost all-metal, very durable construction. Ideal price/performance.



## KERONG

Digital sensor lock, which can be operated by a touch by a up to 8-digit code, or by code and fingerprint reader or by RFID and numeric code, fingerprint reader + Bluetooth for remote control using an application on a mobile device.

**Order Code:** IZN-ZK-A10-XXX-X1 - lock with numeric code  
IZN-ZK-A11-XXX-X1 - with numeric code, fingerprint  
IZN-ZK-A12-XXX-X1 - RFID with numeric code, fingerprint, Bluetooth

## The eco-friendly locker system which saves time, money and stress.

No on-locker management, no broken keys/locks, no need to change harmful lock batteries, etc.

Intelligent, secure, low-maintenance, centrally managed and most user-friendly locker system for storage and delivery lockers in modern offices, smart buildings and other facilities of any size.



### Metra electronic lock

Central unlocking of individual lockers  
Fully concealed (not visible on doors)  
Open locker doors to left, right, up, down and front (for electronic drawers)  
Vandal-proof (no direct access to lock)  
With Auto-Open, Push-Open or Pull-Open locker door dynamics Electric motor-driven (highly reliable) Self-test at every use (each lock/unlock)



### Metra electronic lock with RFID reader

For on-door unlocking lockers  
Status lights (vacant, occupied, alarm, etc.)  
Open locker doors to left, right, up, down and front (for electronic drawers)  
Vandal-proof (no direct access to lock)  
With Auto-Open, Push-Open or Pull-Open locker door dynamics  
Electric motor-driven (highly reliable)  
Self-test at every use (each unlock)



### Metra Display

Central unlocking of individual lockers  
For daily (random visitors) or long-term locker use (employees, students, etc.)  
RFID media/4 -digit PIN Code as locker key  
Used as standalone or with Metra Readers  
Embedded washable keypad  
Built-in RFID reader  
4-digit LED display  
Used with Metra electronic locks



### Metra Touch Display

Central unlocking of individual lockers  
For activity-based/co-working type lockers  
User occupies a vacant locker by himself  
10" touch screen with Full HD resolution  
Multilanguage functionality  
Custom branding of screens (optional)  
For storage and delivery locker system  
Horizontal or Vertical position  
Used as standalone or with Metra Readers



### Metra Reader

For Metra Display/Metra Touch Display  
Central unlocking of individual lockers  
Enables the use of various locker keys  
Use multiple locker keys for single locker  
Reader ISO (ISO RFID)  
Reader Multi (99,9% of RFID) LE (Legic™ RFID)  
Barcode (Barcode, QR Code)  
With genuine HID™ Tech. (HID™ RFID)

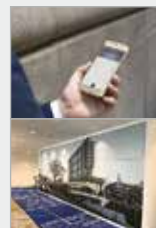

### MyMetraKey mobile app

For remote unlocking of individual lockers  
For activity-based or long-term lockers  
Remote locker use and management Manage multiple lockers from single app  
Enables fully clean-line lockers  
No Metra Displays/Metra Readers needed  
As a sole locker key or in combination with secondary key (PIN code, RFID, etc.) For iOS and Android



### Metra Locker Management Software

Complete remote management and overview of all user and locker activities  
Remotely add/remove media and users  
Remotely unlock any locker or lockers  
For various locker solutions (Daily lockers, Rental lockers, Workplace Lockers and Delivery/Parcel lockers)  
Detailed reports and statistics (optimizing employee locker usage)

### Metra locker system for any solution

**Daily lockers** (daily guests and visitors)

**Rental lockers** (renting out lockers)

**Workplace lockers** (employees, students)

**Delivery and Pickup lockers** (parcel)

**Integrate with any third-party system**

Access control, time and attendance, payment, cashless vending, facility, etc.

# Project realization

Our company provides complete delivery of your order from consultation and production of your chosen product to transport with our fleet or contract carrier including unpacking and placing lockers at the desired location.

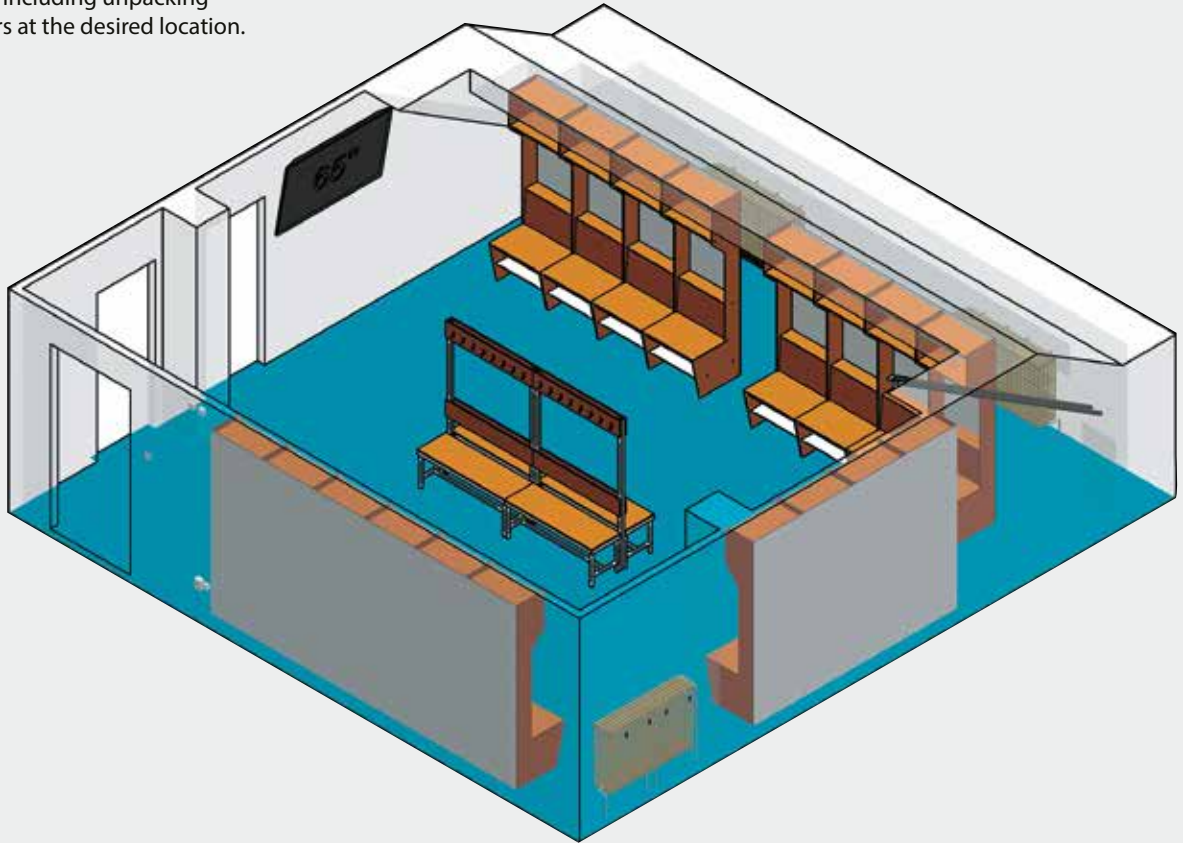

## Technical support

We will be pleased to provide you with expert assistance in selecting the right product. Based on your specific requirements, we propose the most appropriate dimension, construction and optional locking system. If needed, we will measure your desired area and develop graphic design solutions.

## Production

Own production on automated CNC machines which increases the quality and accuracy of our product. The most important thing for us is to meet customer demands and therefore we offer all additional equipment as marking of lockers, keys, hooks, nivelation feets and others which are part of the order.

## Transport

We use our own fleet or contracted carriers to transport our products. According to the place of implementation and shipping order dimensions, we choose the best method of transport. Many projects are implemented in places where a tailgate is needed for unloading goods.



## Assembly

The final step to successfully complete the projects is to unpack and place the lockers. All packaging material will be taken back with us.



# Offer warehouse decors



laminate  
maple mandal



laminate  
fleetwood champagne



laminate  
oak corbridge



laminate  
pine



laminate  
cherry-tree locarno



laminate  
oak bardolino

# Extended offer of decors



nut opera  
0481



nut guarnier  
9455



oak tobacco craft  
K004



nut light select  
K008



nut light lyon  
9614



oak nagano  
8431



zebrano saliard  
8657



oak sand expressive  
K076



crossline caramel  
8362



coconut bolo  
8995



elm smoked liberty  
K018



oak white craft  
K001



crossline latte  
8361



light atelier  
4298



dark atelier  
4299



royal blue  
0125



mamba green  
7190



chilli red  
7113

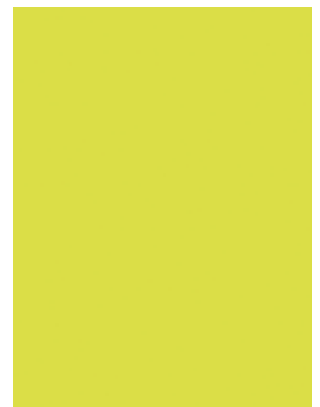

lime grass  
5519





Moving World Prague





FF Mulda



Golfplatz Moossee



Star Fitness Mulhouse



Zoom Cycle Praha



Magna Exteriors & Interiors



Grandhotel Hradec, Pec pod Sněžkou



APAG Elektronik s.r.o.



APAG Elektronik s.r.o.





Office building Vinice



Magna Exteriors & Interiors



Förderschule Schönebeck



3D Yoga Pardubice



Mergon Czech s.r.o.



Schule Eschlikon



Vyncke s.r.o.



Elementary School Pardubice - Polabiny, Npor. Eliáše



Library VŠE, Praha





Jarý s.r.o.



Hardcore Gym Aarau



Golf Resort Lipiny



Tongo, Hradec Králové



Sportcentrum Ivanovice





Schrack Technik GmbH







Fitness und Freizeitwelt Progress







# TRITON

Ausstattung von  
Umkleideräumen, Metallmöbel



www.garderobenspinde.de



www.clotheslockers.eu



www.satniskrinky.cz



## Marketing – Exhibitions

Triton has been participating in exhibitions, starting with its first in 1995.

### International fair FIBO

- Cologne 2011 - 2015

### International fair for firefighters Interschutz

- Hannover 2010, 2015

### International exhibition for firefighters Florian

- Karlsruhe 2013, Dresden 2014, 2016, 2018

### International fair for living Mobitex

- Brno 2008 - 2010

In cooperation with our business partners our products were also presented at:

### International fair for integrated emergency system Infopol -

Kortrijk 2015, 2017, 2019

- **Sport Achat** - Lyon 2019

- **Mountain Planet** - Grenobl 2018

- **ISPO** - Munich 2017

- **Health & Care** - Ghent 2016

- **SportsFair**- Fredericia 2016

- **FSB**- Cologne 2015

- **Suisse Public** - Bern 2013, 2015

- **Sport Achat** - Lyon 2015

- **Golf Europe** - Augsburg, 2012, 2013, 2014

- **Euro Attractions Show** - Paris 2013,  
Amsterdam 2014, Göteborg 2015

- **Green Expo** - Paris 2013

- **Golfshow** - 2011

- **Vienna tec** - Vienna 2012

- **GaLaBau** - Nuremberg 2016



The International Fitness Trade Fair FIBO 2012 - Essen, Germany





MOBITEX 2010 - International Trade Fair of Living – Brno



SUISSE PUBLIC 2013



SportsFair 2016



The International Fitness Trade Fair FIBO 2013 - Cologne, Germany



# Presentation

## Triton showroom

There is no better argument for a product than a demonstration of a sample. For this purpose, we have set up a presentation centre with samples of our products: clothes lockers, golf lockers, lockers for firefighters and rescue services, data cabinets and other products.







# Packaging, transportation

## Packaging

We deliver our products in special packaging. Clothes lockers have edges protected by highly resistant polyurethane foam and the whole locker is then protected with a shrinkwrap against dust and scratching when being transported. All our products are distributed on wooden pallets.

## Transportation

Transportation of our goods is provided with our own vehicles or in cooperation with our contract carriers.





# Certificates



ISO 9001:2015



ISO 14001:2015



ISO 45001:2018



**TRITON**<sup>®</sup>

**Tritón Pardubice, spol. s r. o.**

č.p. 130, 530 02 Starý Mateřov, Czech Republic

Tel.: +420 467 401 111

E-mail: [info@satniskrinky.cz](mailto:info@satniskrinky.cz)

**Triton Chemnitz GmbH**

Teichstraße 11, 09366 Niederdorf, Germany

Tel.: +49 (0) 37296 5498-0

E-Mail: [info@garderobenspinde.de](mailto:info@garderobenspinde.de)

[www.clotheslockers.eu](http://www.clotheslockers.eu)

